

Model No. **CZ-RTC6**
CZ-RTC6W

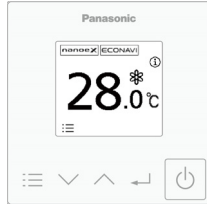

Page

● Safety Precautions	2
● Part Names (Control panel).....	4
● Dimensions	4
● Installation Precautions	5
● Mounting	6
● Setting	9
● Test run	11
● Specifications	11

ENGLISH

Read through the Installation Instructions before you proceed with the installation.
In particular, please carefully read the “Safety Precautions”.

NOTICE

The English text is the original instructions. Other languages are translations of the original instructions.

Safety Precautions

Read before installation

- Read the Installation Instructions carefully to install the remote controller correctly and safely. Be sure to read the "Safety Precautions" before installation.
- After the installation is complete, perform test operation to confirm that no abnormality is present.
- We assume no responsibility for accidents or damages resulting from methods other than those described in the Installation Instructions or methods using unspecified parts. Malfunctions that occur due to unauthorised installation methods are not covered by the product warranty.
- Read the Installation Instructions supplied with indoor units as well.



WARNING

This symbol refers to a hazard or unsafe practice which can result in severe personal injury or death.



CAUTION

This symbol refers to a hazard or unsafe practice which can result in personal injury or product or property damage.



Prohibited matters

Precautions for Installation setup



WARNING

- Turn off the circuit breaker of the units before installation.
- Ask your dealer or professionals for installation and electric work.
- This remote controller must be installed in accordance with National Wiring Regulations.
- Connect and fix the specified cables for wiring securely.
- Do not allow the connection to be exposed to external force from the cables.
- Choose an installation location that sufficiently supports the weight of the remote controller.



CAUTION

- Do not use the remote controller at the following locations.
 - Location where condensation occurs
 - Location where flammable gases, etc. may leak
 - Location where corrosive gases, etc. may leak
 - Location with lots of water or oil droplets (including machine oil)
 - Location where voltage fluctuation frequently occurs
 - Location where there is a machine producing electromagnetic radiation
 - Location where droplets of organic solvents spread
 - Location where acidic or alkaline solutions or special sprays are frequently used
- Do not operate with wet hands.
- Do not wash with water.

Part Names (Control panel)

The control panel colour of CZ-RTC6W is white.

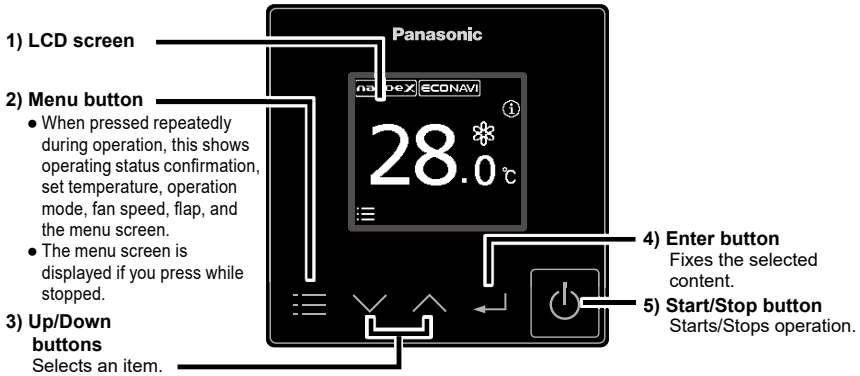

Note

Press centre

No pen

No glove

Dimensions

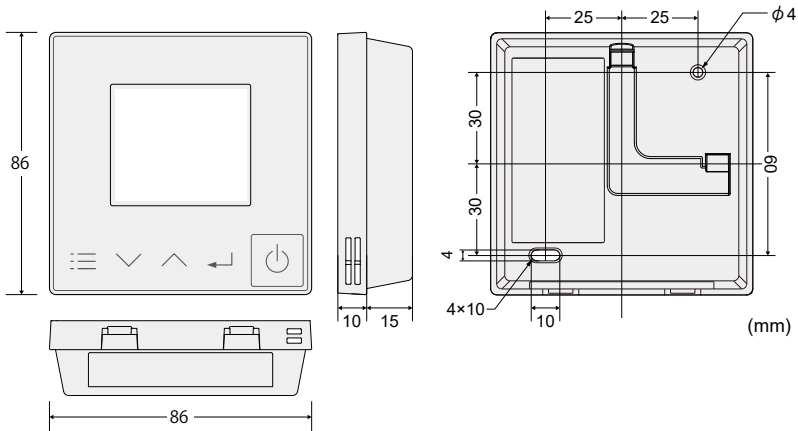

Supplied accessories			
<p>Screw M3.8 x 16 (2)</p>	<p>Operating Instructions (1)</p>	<p>Installation Instructions (1)</p>	<p>Clamper (1)</p>

*Remote control wiring is not supplied. (field supplied item)

Installation Precautions

Installation location

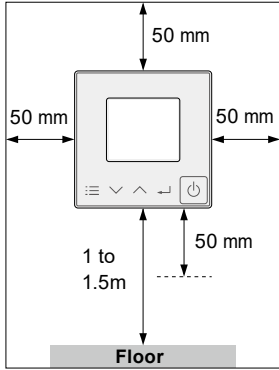

- Install at the height of 1 to 1.5 m from the floor (Location where average room temperature can be detected).
- Install vertically against a wall or suitable supporting structure.
- Keep a space around the remote controller as detailed on the figure shown left.
- Avoid the following locations for installation.
 - By a window, etc. exposed to direct sunlight or external airflow
 - In the shadow or backside of objects deviated from the room airflow
 - Location where condensation occurs (The remote controller is not moisture proof or drip proof)
 - Location near heat source
 - Uneven surface
- Keep distance of 1 m or more from the TV, radio and PC. (Image blur or related noise may occur)

Remote control wiring

Wiring diagram

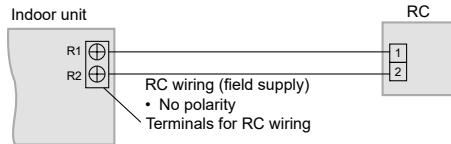

- Type of wiring
 - Use cables of 0.75 to 1.25 mm².
- Total wire length: 500 m or less (The wire length between indoor units should be 200 m or less.)
- Number of connectable units
 - Remote controller: Max. 2
 - Indoor unit: Max. 8

Attention

- Use the field supplied RC wiring with at least 1 mm in thickness of insulation part including the sheath. Wiring Regulations may differ depending on location. For field wiring rules, please refer to your LOCAL ELECTRICAL CODES. You must ensure that installation complies with relevant rules and regulations.
- Be careful not to connect cables to other terminals of indoor units (e.g. power source wiring terminal). Malfunction may occur.
- Do not bundle together with the power source wiring or store in the same metal tube. Operation error may occur.
- If noise is induced to the unit power supply, attach a noise filter.

■ Using 1 indoor unit

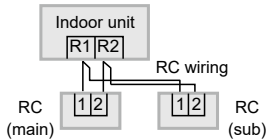

■ Using more than 1 indoor unit

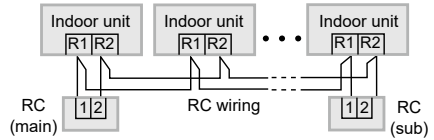

Wiring as shown below is prohibited.

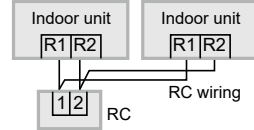
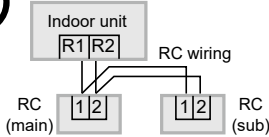

When setting both the main and sub remote controllers

After installation, set one remote controller to [Main] and the other to [Sub] for [Main/sub] for "Setting". (See "Setting" section - "RC. setting mode")

When using the remote controllers* in combination, set the CZ-RTC6(CZ-RTC6W) unit to [Sub].

*CZ-RTC5B, CZ-RTC6BL(CZ-RTC6WBL)

Note Remote controllers can be connected to any indoor unit for operation.

Mounting

1 Remove the top case.

① Insert the screwdriver to the bottom case.

Insert the flat-blade screwdriver to the claws as show in the figure.

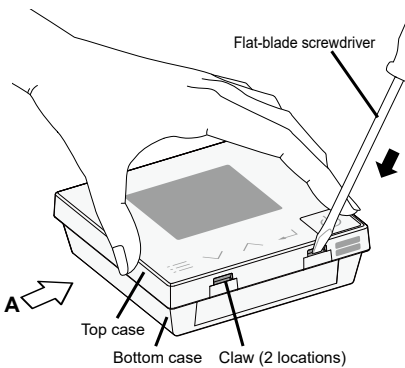

② Push the flat-blade screwdriver in.

Push down the flat-blade screwdriver along with the slope of the claws until the top case comes off.

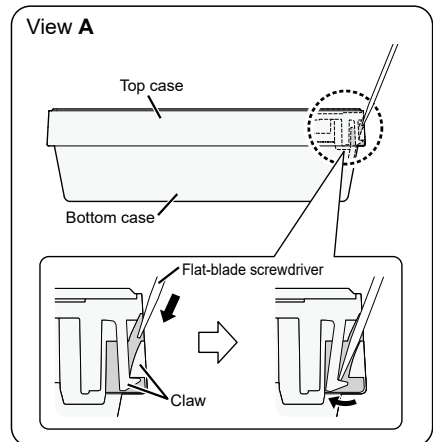

2 Mount to the wall.

There are 2 types of wall-mounting methods: Exposed type and Embedded type.

Attention

Mounting the bottom case

- Tighten the screws securely until the screw heads touch the bottom case.
(Otherwise, loose screw heads may hit the PCB and cause malfunction when mounting the top case.)
- Do not over-tighten the screws.
(The bottom case may be deformed, resulting in the unit becoming detached from the surface it is fixed to.)

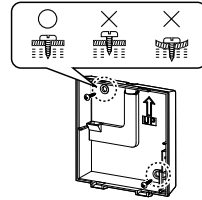

Connection to the remote controller terminal board

- Depress the push button using a round bar or finger, insert the remote control wiring securely from the wiring insertion slot and release the push button.
- Pull the remote control wiring lightly, and confirm it is secured.
- There is the danger of shorting if copper wire is exposed. Make sure the wire is properly inserted.

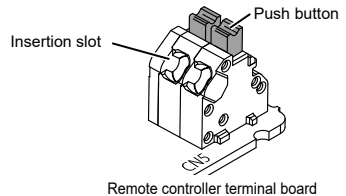

Exposed type

A protective film is attached on the Control panel.

3 Mount the top case.

- Align the claws of the top case and then align the claws of the bottom case.

1 Mount the bottom case to the wall.

- Pass the wire through the wiring hole in the bottom case and lay the wire out along the groove.

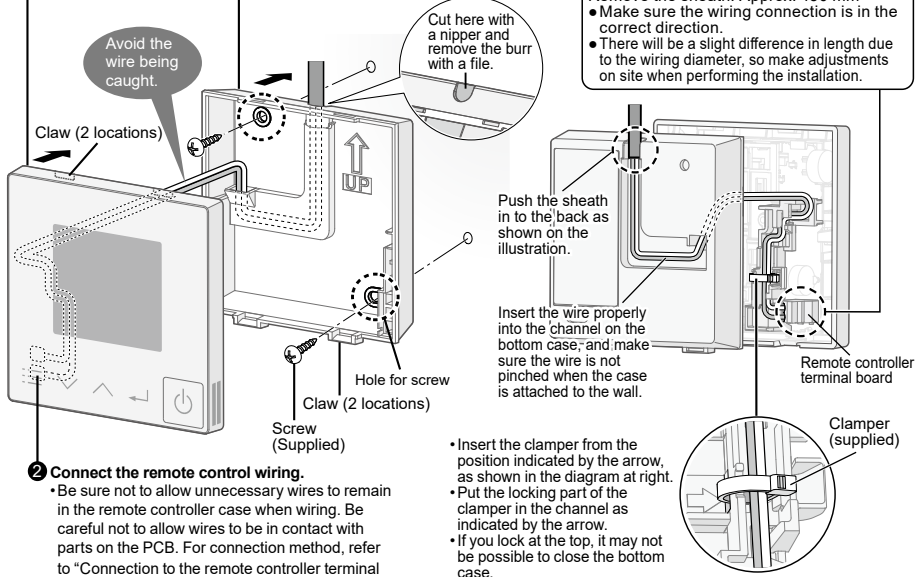

2 Connect the remote control wiring.

- Be sure not to allow unnecessary wires to remain in the remote controller case when wiring. Be careful not to allow wires to be in contact with parts on the PCB. For connection method, refer to "Connection to the remote controller terminal board" in "Attention".

- Insert the clamper from the position indicated by the arrow, as shown in the diagram at right.
- Put the locking part of the clamper in the channel as indicated by the arrow.
- If you lock at the top, it may not be possible to close the bottom case.

*It is also possible to mount in the order 2→1→3.

Embedded type

A protective film is attached on the Control panel.

3 Mount the top case.

- Align the claws of the top case and then align the claws of the bottom case.
- If the wiring is difficult to move, loosen the screw in the lower case, work on the wiring, then screw in the screw after finishing the work.

Avoid the wire being caught.

1 Mount the bottom case to the wall.

- Pass the wire through the wiring hole in the bottom case.

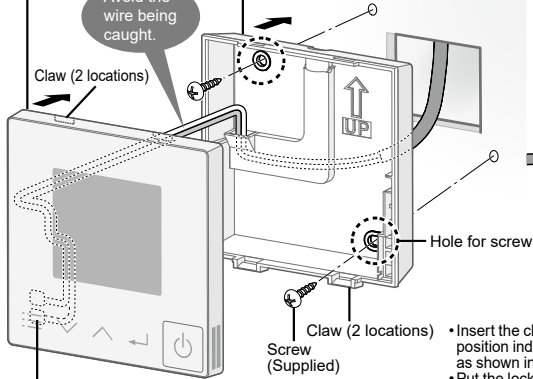

2 Connect the remote control wiring.

- Be sure not to allow unnecessary wires to remain in the remote controller case when wiring. Be careful not to allow wires to be in contact with parts on the PCB. For connection method, refer to "Connection to the remote controller terminal board" in "Attention".

Pass the wire under the rib.



Remove the coating. Approx. 9 mm



- Make sure the wiring connection is in the correct direction.

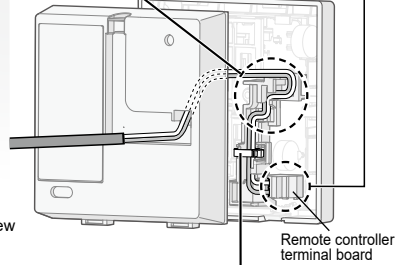

- Insert the clamber from the position indicated by the arrow, as shown in the diagram at right.
- Put the locking part of the clamber in the channel as indicated by the arrow.
- If you lock at the top, it may not be possible to close the bottom case.

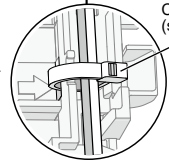

*It is also possible to mount in the order 2 → 1 → 3.

Setting

Preparation: Turn on the circuit breaker of units and then turn the power on. The remote controller starts, and wait until the [Assigning] display disappears.
 (If [Assigning] continues to blink for 10 minutes or more, check the address setting of indoor units. Refer to indoor/outdoor unit installation details.)

Menu

Language

1 ■ When stopped

Press .

■ When operating

Press  repeatedly until the menu screen is displayed.

• To return to the top screen, press .

2 Select [Language].

Press   → .

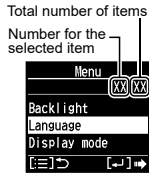

3 Select the language to display from among 7 languages shown on the right.

Press   →  → .

(Press to finish.)

• Default setting : ENGLISH



Maintenance func

■ RC. setting mode ■ Auto address ■ Detailed settings ■ Sensor info. ■ Service check

Check this item as necessary.
 Steps 1 and 2 are common operations for each item.

1 Press and hold the 3 buttons simultaneously, for at least 4 seconds.

Press  ,  , .

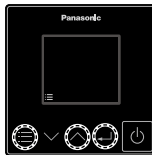

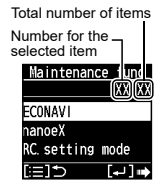

2 Select the item to set.

Press   → .



RC. setting mode

3 Set. (Select the Code no. and Set data.)

Press   →  . (Repeat)

4 Press .

• After Selecting [YES], the unit restarts.

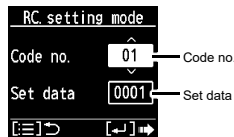

Code no.		Set data
01	Main/sub	Set this when using 2 remote controllers. • 0000: Sub • 0001: Main (factory setting)
2F	Password change	Set the administrator password. • 0000 to 9999 • 0000 (factory setting)

Auto address

- 3 Set.**
(Select the Code no. [A1] and O/D unit no.)

Press → . (Repeat)

- 4 Press** .
• After Selecting [YES], the unit restarts.

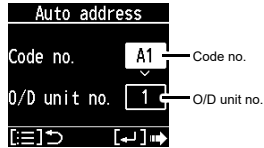

Code no.	O/D unit no.
A1	1

Set the Auto address for each O/D unit no.
Select the O/D unit no. (outdoor unit) for Auto address. • Outdoor unit number

Attention

- Set Auto address after all units are turned on and 90 seconds or more have passed.
- Operate the units after Auto address is set and 90 seconds or more have passed.

Detailed settings

- 3 Set.**
(Select the indoor unit number, Code no. and Set data.)
(When selecting Code no., refer to the following table.)

Press → . (Repeat)

- 4 Press** .
• After Selecting [YES], the unit restarts.

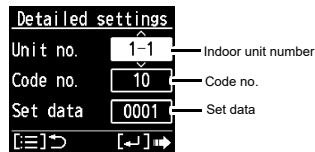

Code no.	Set data
31	Vent output setting
32	Temp sensor setting
33	Temp display setting

Set this when connecting a commercially sold fan, etc. to the ventilation fan output "FAN DRIVE:2P (White)" on the indoor control board. *Dedicated cables (optional) are required.	• 0000: Not connected • 0001: Connected
Set this when measuring the room temperature with the room temperature sensor of the remote controller. • When using the main and sub remote controllers, the main one is enabled. • When using with the remote sensor in combination, set the indoor unit setting data. * This setting is not available during group-controlling.	• 0000: Indoor unit • 0001: Remote controller
Set the type of temperature display.	• 0000: °C • 0001: °F

* Depending on the type of indoor unit, Code no. may be displayed with 6 digits. In this case, read as follows.
e.g. 10 → 000010

Sensor info.

This displays each sensor temperature of the remote controller, indoor units and outdoor units.

- 3 Select.**
(Select the unit number and Code no.)

Press → . (Repeat)

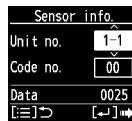

- 4 Confirm the content.**

press .

- Pressing will return to the Maintenance func screen.

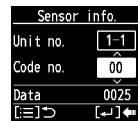

Service check

This displays the alarm history.

- 3 Confirm the content.**

Press .

Information of the last 4 errors is displayed.
[-] shows that no error has occurred.

- Pressing will return to the Maintenance func screen.
- To delete the error history, press and select [YES].

Service check		
Unit no.	Alarm	
1	1-1	E04
2	1-1	F10
3	1-2	P01

Delete

Test run

- 1 Press and hold the 3 buttons simultaneously, for at least 4 seconds.**

Press , , .

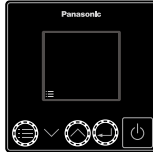

- 2 Select [Test run].**
Press → .

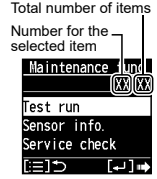

- 3 Select [ON].**
(The unit enters the test operation mode. Then, [TEST] turns on.)
Press

→ .

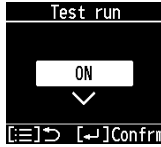

Press .

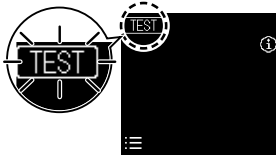

- 4 Perform the test operation.**

Press .



- 5 Finish the test operation.**

Perform step 1 and 2, and then select [OFF] in step 3. ([TEST] display disappears.)

- The test operation can be performed in Heat or Cool mode.
- Temperature cannot be changed.
- The test operation mode is automatically turned off in 60 minutes. (To prevent continuous test operation)
- Outdoor units do not operate for approx. 3 minutes after the power is turned on or operation is stopped.

Attention

- Do not use this mode for purposes other than the test operation. (To prevent overload of the units)
- Read the Installation Instructions supplied with the units.

Specifications

Model No.	CZ-RTC6 / CZ-RTC6W
Dimensions	(H) 86 mm × (W) 86 mm × (D) 25 mm
Weight	0.09 kg
Temperature/Humidity range	0 °C to 40 °C / 20 % to 80 % (no condensation)*Indoor use only.
Power Source	DC16 V (supplied from indoor unit)
Number of connected indoor units	Indoor unit: Up to 8 units (Within group-controlling)

